

# Synchrongetriebemotoren - SP-Serie

## Synchronous Gear Motor - Series SP

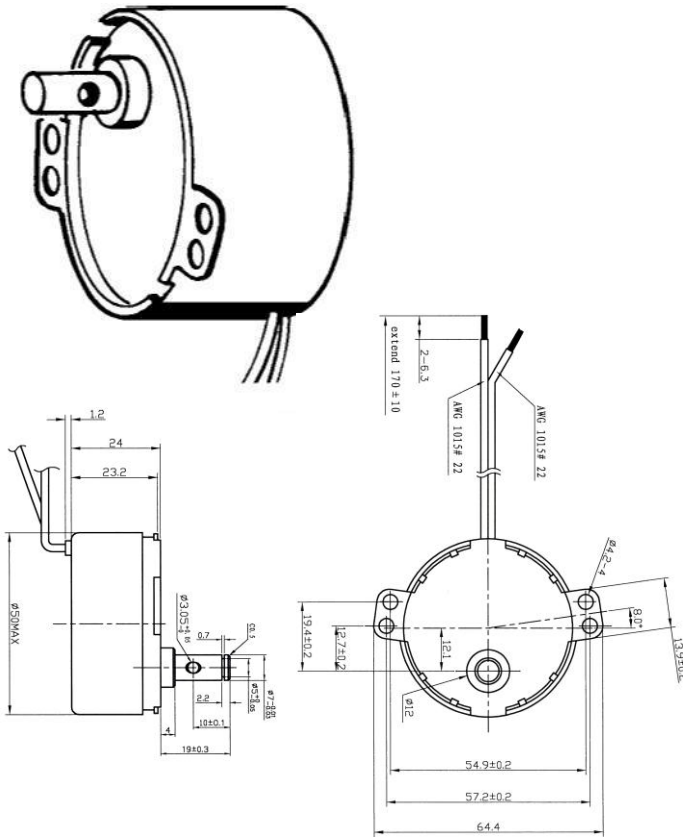

Bestell-Nr. Order no. 230 V 50 Hz	UpM rpm	Dreh- moment torque Ncm	Drehrichtung/Rotating direction r= rechts / l = links cw = clockwise ccw = counter clockwise
210 010 220	1	100	r / cw
210 011 220	1	100	l / ccw
210 250 220	2,5	70	r / cw
210 251 220	2,5	70	l / ccw
211 251 220	2,5	70	l- r / cw - ccw
210 500 220	5	40	r / cw
210 501 220	5	40	l / ccw
900 229	5	40	l- r / cw - ccw
210 100 220	10	25	r / cw
210 101 220	10	25	l / ccw
210 111 220	10	25	r- l / cw - ccw
210 020 220	20	12	r / cw
210 021 220	20	12	l / ccw
211 022 220	20	12	r- l / cw - ccw
210 030 220	30	6	r / cw
210 031 220	30	6	l / ccw
210 131 220	30	6	r- l / cw - ccw

**Montagebeispiel:**  
Motor inklusive Zubehör

**Assembling example**  
Motor incl. accessories

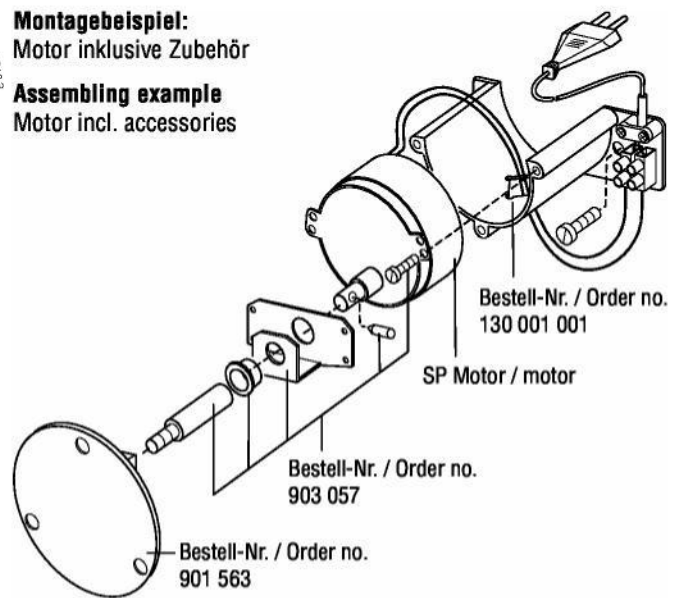

**Auch lieferbare Nennspannungen:** 6, 12, 24, 42, 115 Volt AC  
(Mindestabnahme 500 Stück)

**Other available rated voltages :** 6, 12, 24, 42, 115 Volt AC  
(Minimum order quantity 500 pcs)













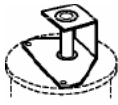

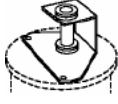



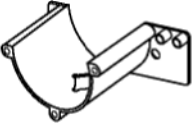

Kundenspezifische Achsen auf Anfrage.  
Customized shafts on inquiry.

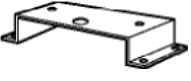
**Umfangreiches Standardzubehör auf Wunsch erhältlich.**  
**Extensive standard accessory program available too.**

### Technische Daten / Technical data

<b>Nennspannung / Voltage</b>	110 - 120 V ~ 220 - 240 V ~	110 - 120 V ~ 220 - 240 V ~	110 - 120 V ~ 220 - 240 V ~	110 - 120 V ~ 220 - 240 V ~	110 - 120 V ~ 220 - 240 V ~	110 - 120 V ~ 220 - 240 V ~
<b>Frequenz / Frequency</b>	60 / 50 Hz	60 / 50 Hz	60 / 50 Hz	60 / 50 Hz	60 / 50 Hz	60 / 50 Hz
<b>Stromaufnahme Rated current</b>	40 / 20 mA	40 / 20 mA	40 / 20 mA	40 / 20 mA	40 / 20 mA	40 / 20 mA
<b>Leistungsaufnahme Rated input</b>	4 W	4 W	4 W	4 W	4 W	4 W
<b>Pol / Pole</b>	10	10	10	10	10	10
<b>UPM ca. / RPM approx.</b>	1 / 1.2	2,5 / 3	5 / 6	10 / 12	20 / 24	30 / 36
<b>Drehrichtung normal Rotating direction normal</b>	Rechts / cw	Rechts / cw	Rechts / cw	Rechts / cw	Rechts / cw	Rechts / cw
<b>Temp. Erhöhung /Temp.rise</b>	< 60 K	< 60 K	< 60 K	< 60 K	< 60 K	< 60 K
<b>Isolationsklasse Insulat. strength</b>	A	A	A	A	A	A
<b>Nennspannungsabweichung Permiss. Volt fluctation</b>	+ / - 15%	+ / - 15%	+ / - 15%	+ / - 15%	+ / - 15%	+ / - 15%
<b>Zul. Umgebungstemperatur Permiss. ambient temperature</b>	-5° bis + 40° C -5° to + 40° C	-5° bis + 40° C -5° to + 40° C	-5° bis + 40° C -5° to + 40° C	-5° bis + 40° C -5° to + 40° C	-5° bis + 40° C -5° to + 40° C	-5° bis + 40° C -5° to + 40° C

## Standardzubehör / Standard Accessories

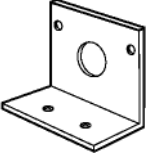
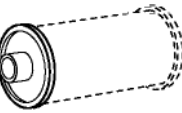
	Flansch Ø 29 mm <b>Bestell-Nr.</b> 901 064	flange Ø 1 ¼" <b>Order no.</b> 901 064		Stelling für Seilrolle Ø 10 mm <b>Bestell-Nr. Metall</b> 902 279	adjusting nut for sheaves Ø 3/8" <b>Order no.</b> 902 279
	Metallflansch Ø 65mm <b>Bestell-Nr.</b> 901 063	metal flange Ø 2 ½" <b>Order no.</b> 901 063		Stützlager <b>Bestell-Nr.</b> 903 057	support-bearing <b>Order no.</b> 903 057
	Kunststoffflansch Ø 65 mm <b>Bestell-Nr.</b> 901 563	plastic flange Ø 2 ½" <b>Order no.</b> 901 563		Stütz- und Drucklager <b>Bestell-Nr.</b> 903 058	support- and thrust bearing <b>Order no.</b> 903 058
	Kupplungsflansch Ø 65 mm <b>Bestell-Nr.</b> 900 150	flange with coupling Ø 2 ½" <b>Order no.</b> 900 150		Kurbelachse <b>Bestell-Nr.</b> 901 176	crank shaft <b>Order no.</b> 901 176
	Flansch mit Schubstange 65 mm <b>Bestell-Nr. Metall</b> 901 875	flange with crank 2 ½" <b>Order no. Metal</b> 901 875		Motorfuß, <b>Bestell-Nr.</b> 130 001 001	motor bracket <b>Order no.</b> 130 001 001
	Flansch mit Schubstange 150 mm <b>Bestell-Nr. Metall</b> 901 073	flange with crank 6" <b>Order no. Metal</b> 901 073		Kupplung für 7 mm Achse <b>Bestell-Nr.</b> 901 983	coupling for 7 mm shaft <b>Order no.</b> 901 983
	Flansch mit Schubstange a' 150 mm <b>Bestell-Nr. Metall</b> 901 190	flange with crank a' 6" <b>Order no. Metal</b> 901 190		Traverse <b>Bestell-Nr.</b> 123 304 001	Suspension bracket <b>Order no.</b> 123 304 001
	<b>Bestell-Nr. Kunststoff</b> 901 074	<b>Order no. Plastic</b> 901 074		Aufsteckachse mit Linksgewinde <b>Bestell-Nr.</b> 900 827	axle with left-handed thread <b>Order no.</b> 900 827
	Flansch mit Schubstange a' 150 mm <b>Bestell-Nr. Metall</b> 901 191	flange with crank a' 6" <b>Order no. Metal</b> 901 191		Aufsteckachse, Abmessungen auf Anfrage <b>Bestell-Nr.</b> 900 827	axle with wire lengthening dimensions on inquiry <b>Order no.</b> 900 827
	<b>Bestell-Nr. Kunststoff</b> 901 191	<b>Order no. Plastic</b> 901 191		Zahnrad Modul 1, Zähnezah auf Anfrage <b>Bestell-Nr.</b> 900 827	gear wheel, modul 1, no. of teeth on inquiry <b>Order no.</b> 900 827
	Seilrolle incl. Stelling Ø 50 mm <b>Bestell-Nr.</b> 901 369	rope sheave incl. adj. nut Ø 2" <b>Order no.</b> 901 369		Winkel <b>Bestell-Nr.</b> 122 279020	angle bracket <b>Order no.</b> 122 279 020
	Seilrollenhälfte für Papprohr Ø 50 mm <b>Bestell-Nr.</b> 123 655 000	sheave-set for tube Ø 2" <b>Order no.</b> 123 655 000			

Technische Änderungen vorbehalten

Subject to technical changes